

GB Installation instructions

Dear Customer,

Congratulations on purchasing this STEINEL Infrared Sensor and thank you for the confidence you have shown in us. You have chosen a high-quality product that has been manufac-

tured, tested and packed with the greatest care. Please familiarise yourself with these instructions before attempting to install the sensor since prolonged reliable and trouble-free operation will only be ensured

if it is installed properly.

We hope your new Infrared Sensor will give you lasting satisfaction.

System components

- 1** Security screw
- 2** Front cover
- 3** Lens (can be removed and turned for selecting the max. basic reach settings of 5 m or 12 m)
- 4** Light threshold setting control 2 – 2000 lux
- 5** Time setting control 5 sec. – 15 min.
- 6** Clip (housing can be flipped up for assembly and connection to mains power supply)

Technical specifications

Dimensions (H x W x D):	120 x 76 x 56 mm	
Output:	Incandescent / halogen lamp load	1000 W
	Fluorescent lamps, electronic ballast	1000 W
	Fluorescent lamps, uncorrected	500 VA
	Fluorescent lamps, series-corrected	406 VA
	Fluorescent lamps, parallel-corrected	406 VA
	Low-voltage halogen lamps	1000 VA
	LED < 2 W	16 W
	2 W < LED < 8 W	64 W
	LED > 8 W	64 W
	Capacitive load	132 µF
Connection:	230-240 V, 50 Hz	
Detection angle:	180° horizontal, 90° vertical	
Sensor reach:	basic setting 1: 5 m max. basic setting 2: 12 m max. (factory setting) + precision adjustment from 1-12 m by means of clip-on shrouds	
Time setting:	5 sec. - 15 min. (factory setting: 5 sec.)	
Light threshold:	2-2000 lux (factory setting: 2000 lux)	
Enclosure:	IP 54	
Temperature range:	-20°C to +50°C	

Principle

The IS 180-2 is equipped with two 120° pyro sensors which detect the invisible heat emitted by moving objects (people, animals etc.). The heat detected is electronically converted into a signal that switches on loads (e.g. a light) connected to it. Heat is not

detected through obstacles, such as walls or panes of glass. Heat radiation of this type will, therefore, not trigger the sensor. With a 90° angle of aperture, the two pyro sensors cover a detection angle of 180°. The lens can be removed and turned, thereby permitting two max.

basic reach settings of 5 m or 12 m. Using the wall mounts provided with the unit, the infrared sensor can easily be fitted to internal and external corners.

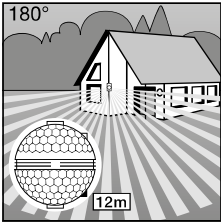

Reach max. 12 m

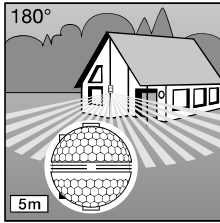

Reach max. 5 m

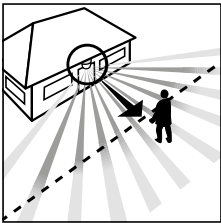

Direction of approach:
towards the sensor

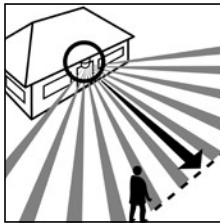

Direction of approach:
across the detection zone

Important: The most reliable way of detecting motion is to install the unit so that the sensor is aimed across the direction in which a person would walk and by ensuring that no obstacles (such as trees, walls etc.) obstruct the line of sensor vision.

⚠ Safety warnings

- Disconnect the power before attempting any work on the motion detector.
 - The electrical connection lead must be dead during installation. Therefore, switch off the power supply first and check that the circuit is disconnected using a voltage tester.
 - Installation of the sensor involves work on the mains power supply. This work must therefore be carried out professionally in accordance with the applicable wiring regulations and supply conditions.
 - Please note that the sensor must be protected by a 10 A circuit breaker.
- The mains supply lead must be no greater than 10 mm in diameter.
- Only carry out time and light threshold settings with the lens fitted.

Installation/Wall mounting

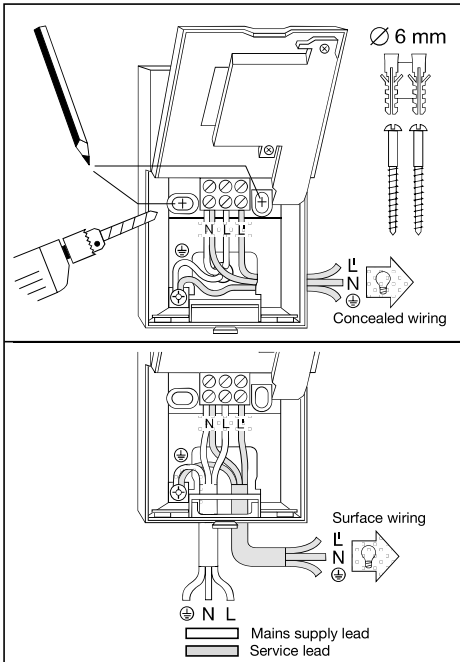

The site of installation should be at least 50 cm from a light because heat radiated from it may trigger the sensor unintentionally. To obtain the specified ranges of 5/12 m, the sensor should be installed at a height of approx. 2 m.

Installation procedure:

1. Detach front cover [2].
2. Release clip [6] and flip up lower half of housing.
3. Mark drill holes, 4. Drill the holes, insert wall plugs (6 mm dia.), 5. Break open cable entry for surface or concealed wiring.
6. Feed through mains supply and service cable and connect to terminals. Use sealing plugs for surface wiring.

a) Connect mains supply lead

The mains supply leads is a 2 to 3-core cable:

- L** = phase conductor
- N** = neutral conductor
- PE** = protective-earth conductor (⊕)

If you are in any doubt, you must identify the cables using a voltage tester; once you have done so, disconnect the power supply again. Connect the phase (**L**) and neutral conductor (**N**) to the clamp-type terminal. Connect the protective earth conductor to the earth terminal (⊕). A power ON/OFF switch may of course be installed in the power supply lead. Alternatively, you may use a normally closed contact pushbutton to activate the sensor manually for the duration of the time setting.

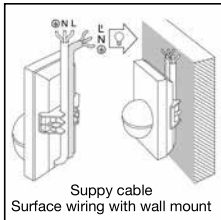

Note: The internal-corner wall mount may be used for mounting the sensor to the wall. The cables can be conveniently routed down the surface of the wall behind the unit and fed through the cable entry.



b) Connect service lead



The service supply lead to the light is also a 2 to 3-core cable. Connect the light's current-carrying conductor to the terminal marked L'. The service lead neutral conductor must be connected to the terminal marked N together with the

mains lead neutral conductor. Connect the protective-earth conductor to the earth contact (⊖).

7. Screw on housing and close again.

8. Fit lens (set reach to either 5 m or 12 m max), see 'Reach setting' section.

9. Select time  and light threshold setting  (see 'Functions' section).

10. Locate front cover  and fit security screw  to protect cover from unauthorised removal.

Important: Reversing the connections may result in damage to the unit.

Installation using corner wall mount

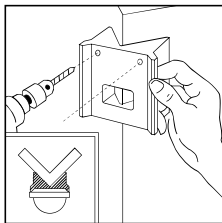
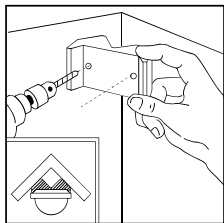

With the corner wall brackets, the IS 180-2 can be conveniently mounted on inside and outside corners. Use the corner wall bracket as a drilling template when drilling the holes. In this way you place the drill hole at the right angle and the corner wall bracket can be mounted without any problems.

The corner wall brackets are available separately:
4007841085131 black
4007841085148 white

Functions

Once you have connected the unit to the mains power supply, closed the housing and fitted the lens, you are

ready to put the system into operation. Two setting controls are concealed behind the front cover .

Important: Only carry out time and light threshold settings with the lens fitted.

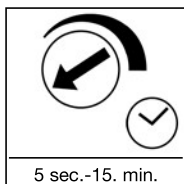

Switch-off delay (time setting)

The chosen light ON time can be varied continuously from approx. 5 sec. to a maximum of 15 min. Turning the adjustment screw fully anti-clockwise selects the shortest time of approx. 5 sec., turning the adjust-

ment screw fully clockwise the longest time of approx. 15 min. The shortest time setting is recommended for setting the detection zone and performing the walk test.

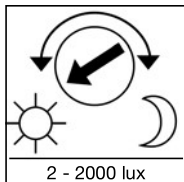

Twilight setting (response threshold)

The chosen detector response threshold can be adjusted continuously from approx. 2 lux to 2000 lux. Turning the adjustment screw fully anti-clockwise selects daylight operation at approx. 2000 lux. Turning

the adjustment screw fully clockwise selects twilight operation at approx. 2 lux. The adjustment screw must be turned fully anti-clockwise for setting the detection zone and performing the walk test in daylight.

Basic reach settings

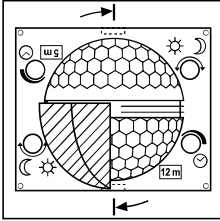

The lens of the IS 180-2 is divided into two detection zones. One half covers a max. reach of 5 m, the other half a max. reach of 12 m (when installed at a height of approx. 2 m). After fitting the lens (press lens firmly into the channel provided) you will see the max. reach setting (12 m or 5 m) at the bottom right.

Using a screwdriver, the lens can be unclipped from the groove at the side and re-positioned for the reach you require.

Examples

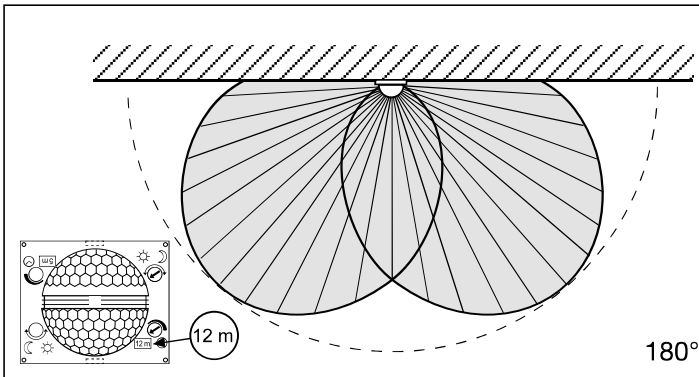
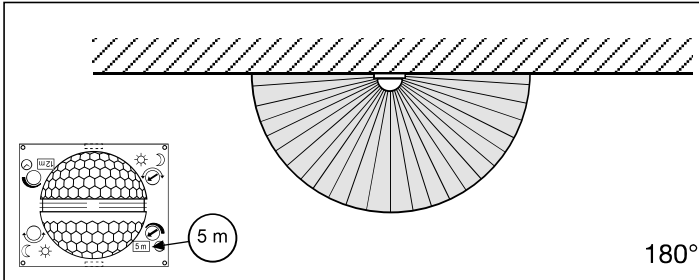

Precision adjustment using shrouds

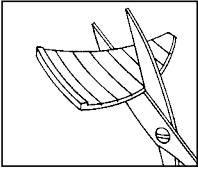

Shrouds may be used to define the detection zone exactly as you require in order, for example, to blank out or specifically target paths or neighbouring premises.

The shrouds can be divided or cut with a pair of scissors along the vertical and horizontal grooves. They can be clipped into the top channel around the centre of the lens. They are fixed in place by fitting the front cover.

(See below: Examples showing how to reduce the angle of detection and shorten the reach).

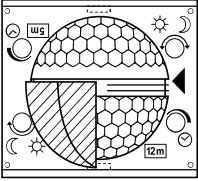

Examples

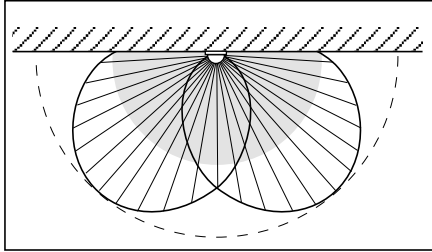
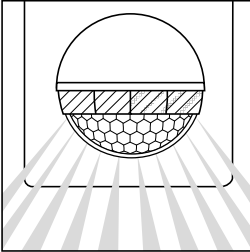
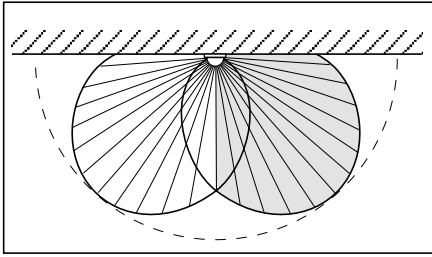
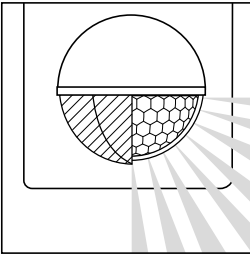

Wiring examples

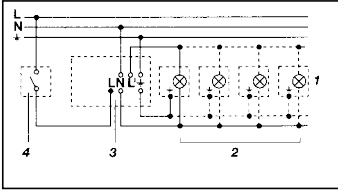

1. Light without neutral conductor

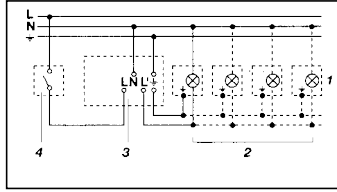

2. Light with neutral conductor

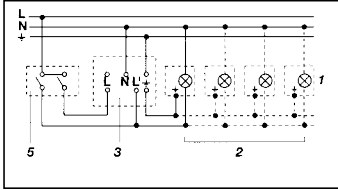

3. Connection using series switch for manual and automatic operation

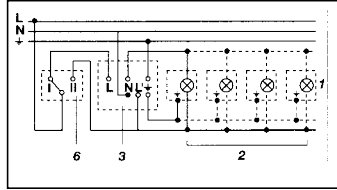

4. Connection to double-throw switch for permanent light ON and automatic operation

Setting I: automatic operation
Setting II: manual operation for permanent light ON

Important: the unit cannot be switched off, but operated only at settings I and II.

- 1) e.g. 1-4 x 100 W filament bulbs
- 2) Service load, light of 1000 W max. (see Technical specifications)
- 3) IS 180-2 connection terminals
- 4) Indoor switch
- 5) Indoor series switch, manual, automatic
- 6) Indoor double-throw switch, automatic, permanent light ON

Operation/Maintenance

The Infrared Sensor is suitable for switching light on and off automatically. The unit is not suitable for special burglary alarm systems since it lacks the tampering protection prescribed for this purpose.

Weather conditions may affect the way the motion detector works. Strong gusts of wind, snow, rain or hail may cause the light to come on when it is not wanted because the sensor is unable to distinguish

sudden changes of temperature from sources of heat. The detector lens may be cleaned with a damp cloth if it gets dirty (do not use cleaning agents).

Troubleshooting

Malfunction	Cause	Remedy
IS 180-2 without power	<ul style="list-style-type: none"> ■ Fuse faulty; not switched ON ■ Short circuit ■ Mains switch OFF 	<ul style="list-style-type: none"> ■ Renew fuse, switch on mains power switch, check wiring with voltage tester ■ Check connections ■ Switch on
IS 180-2 will not switch ON	<ul style="list-style-type: none"> ■ Twilight control set to nighttime mode during daytime operation ■ Bulb faulty ■ Mains power switch OFF ■ Fuse faulty ■ Detection zone not properly targeted 	<ul style="list-style-type: none"> ■ Adjust setting ■ Change light bulb ■ Switch on ■ Renew fuse, check connection if necessary ■ Re-adjust
IS 180-2 will not switch OFF	<ul style="list-style-type: none"> ■ Continuous movement in the detection zone ■ Light is in detection zone and keeps switching on as a result of temperature change ■ Set to continuous operation by indoor series switch ■ Position Wi-Fi device very close to the sensor 	<ul style="list-style-type: none"> ■ Check detection zone and re-adjust if necessary or fit shrouds ■ Re-adjust zone or apply shroud ■ Set series switch to automatic mode ■ Increase distance between Wi-Fi device and sensor
IS 180-2 keeps switching ON/OFF	<ul style="list-style-type: none"> ■ Light is in detection zone ■ Animals moving in detection zone ■ Heat source (e.g. extractor hood outlet) in detection zone 	<ul style="list-style-type: none"> ■ Adjust detection zone or fit shrouds, increase distance ■ Adjust detection zone or fit shrouds ■ Adjust detection zone or fit shrouds
IS 180-2 switches on when it should not	<ul style="list-style-type: none"> ■ Wind is moving trees and bushes in the detection zone ■ Cars in the street are being detected ■ Sudden temperature changes due to weather (wind, rain, snow) or air expelled from fans or open windows 	<ul style="list-style-type: none"> ■ Blank off sections using shrouds ■ Blank off sections using shrouds ■ Adjust detection zone or change site of installation

Disposal

Electrical and electronic equipment, accessories and packaging must be recycled in an environmentally compatible manner.



Do not dispose of electrical and electronic equipment as domestic waste.

EU countries only:

Under the current European Directive on Waste Electrical and Electronic Equipment and its implementation in national law, electrical and electronic equipment no longer suitable for use must be collected separately and recycled in an environmentally compatible manner.

Manufacturer's Warranty

This STEINEL product has been manufactured with utmost care, tested for proper operation and safety and then subjected to random sample inspection. Steinel guarantees that it is in perfect condition and proper working order.

The warranty period is 36 months and starts on the date of sale to the consumer. We will remedy defects caused by material flaws or manufacturing faults. The warranty will be met by repair or replacement of defective parts at our own discretion. The warranty shall not cover damage to wear parts, damage or defects caused by improper treatment or maintenance.

Further consequential damage to other objects shall be excluded. Claims under the warranty will only be accepted if the unit is sent fully assembled and well-packed with a brief description of the fault, a receipt or invoice (date of purchase and dealer's stamp) to the appropriate Service Centre.

Service:

Our Customer Service Department will repair faults not covered by warranty or after the warranty period. Please send the product well-packed to your nearest service station.

3 YEAR
MANUFACTURER'S
WARRANTY